

M01

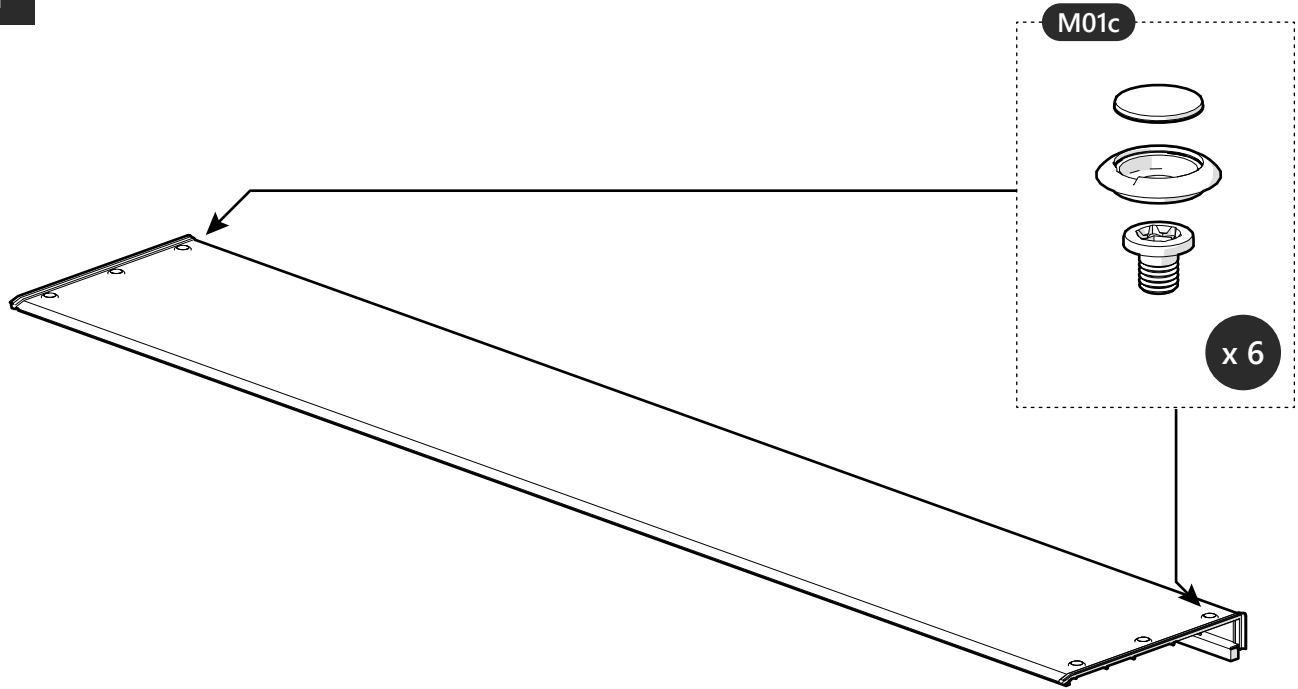

M02

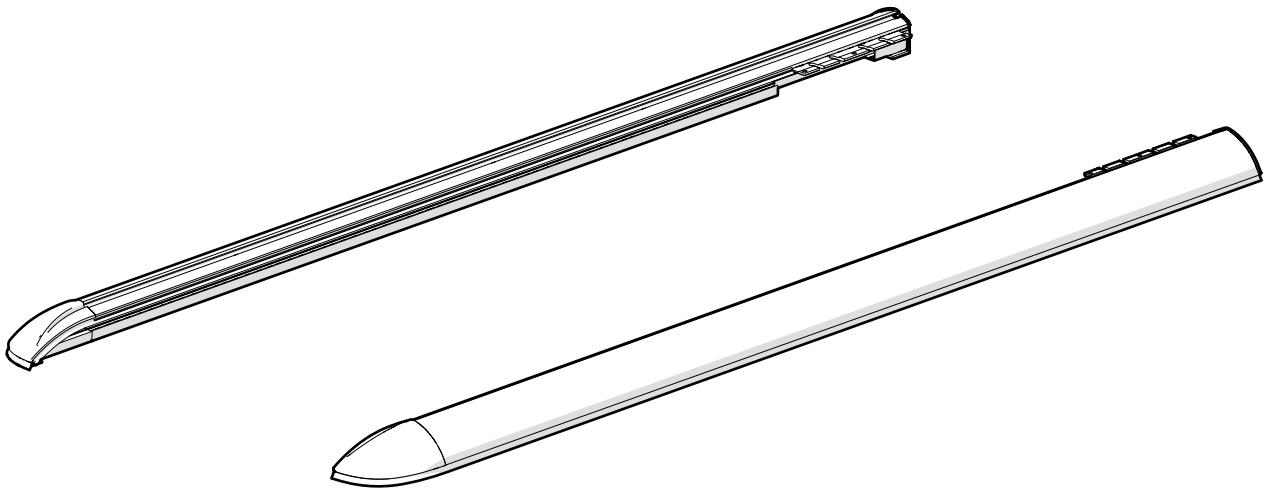

**M03**

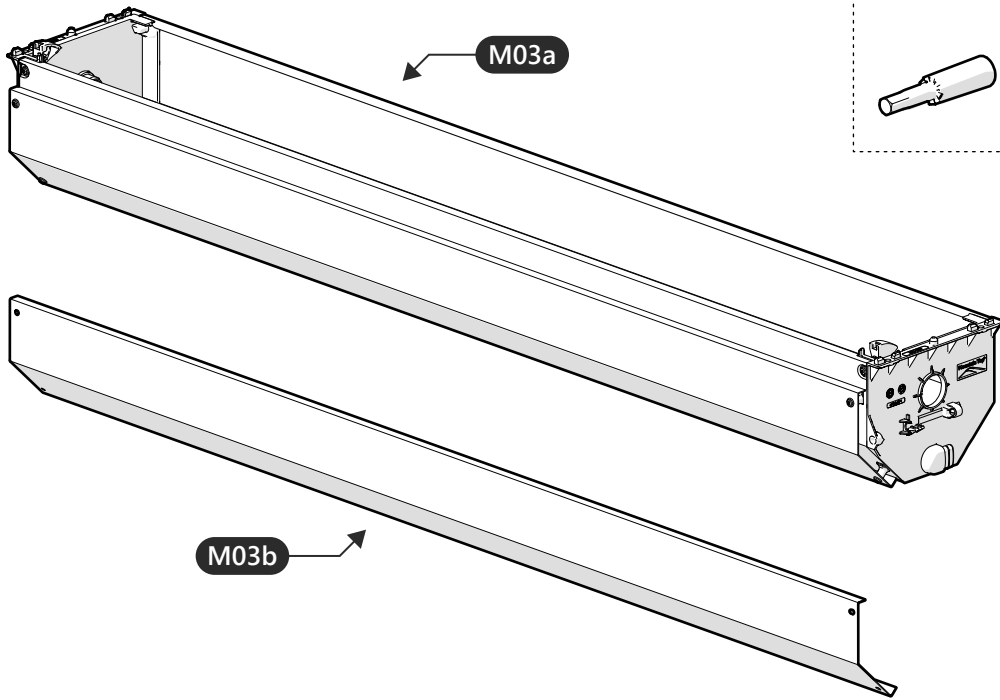

**M04**

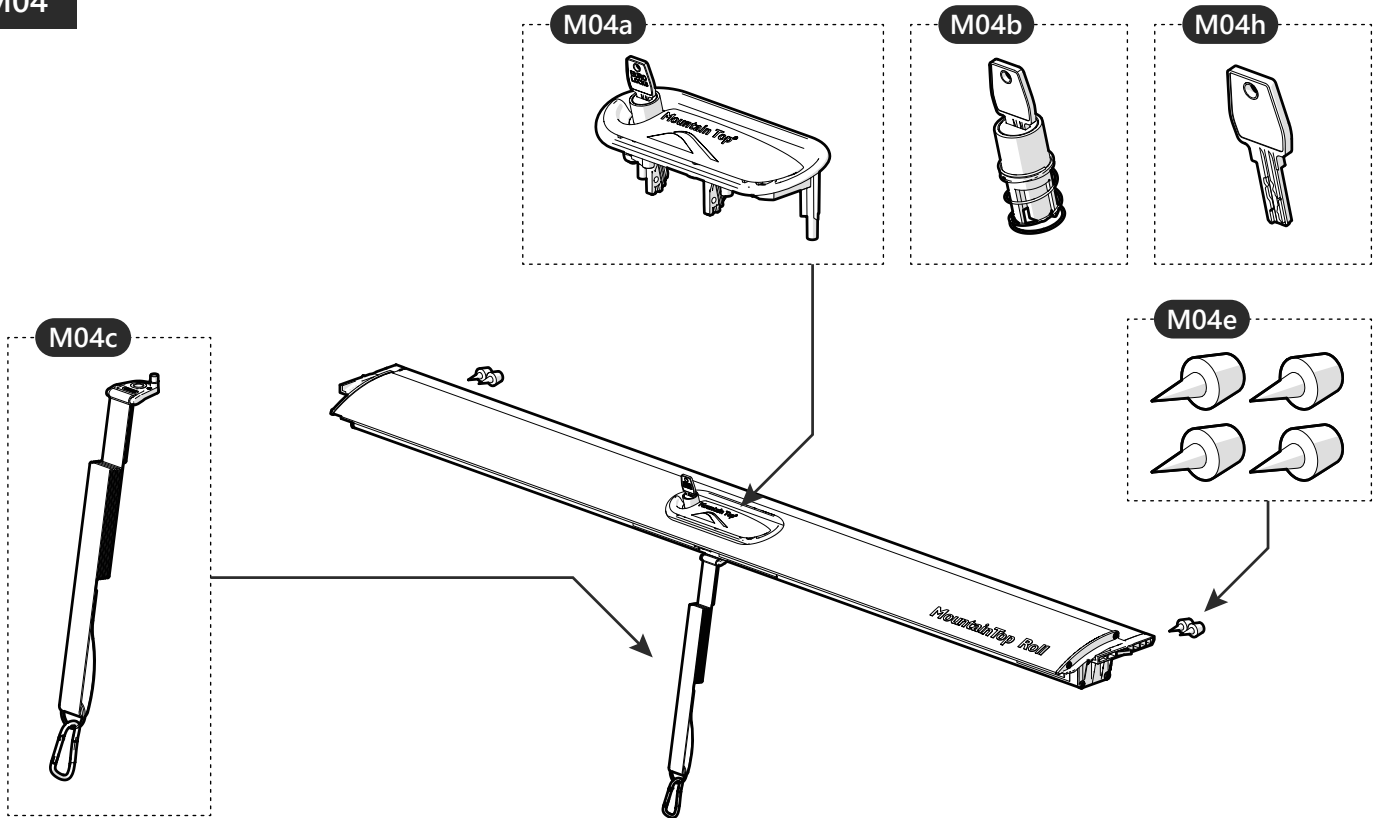

### M06

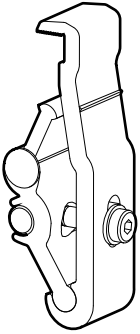

**M06c** x 1  
FORD

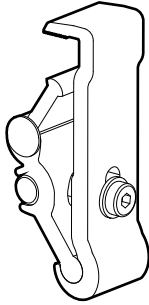

**M06d** x 1  
TOYOTA  
ISUZU

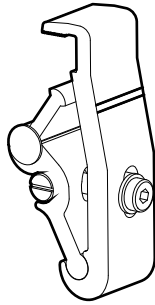

**M06e** x 1  
VOLKSWAGEN

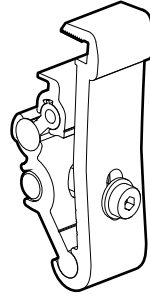

**M06f** x 1  
NISSAN

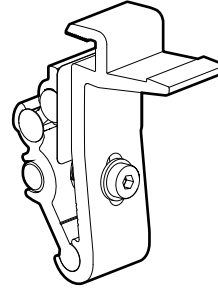

**M06g** x 1  
TOYOTA

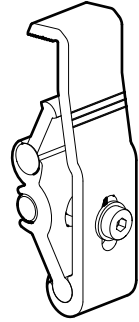

**M06h** x 1  
MITSUBISHI

### M07

**M07e**

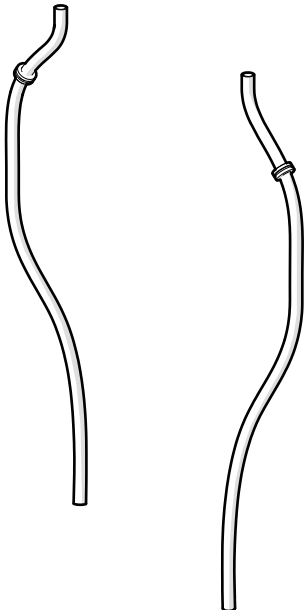

**M07c**

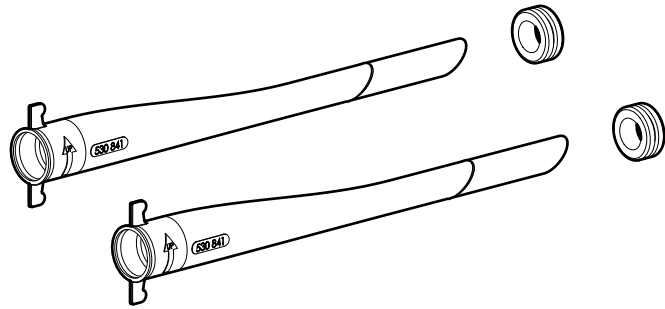

**M07d**

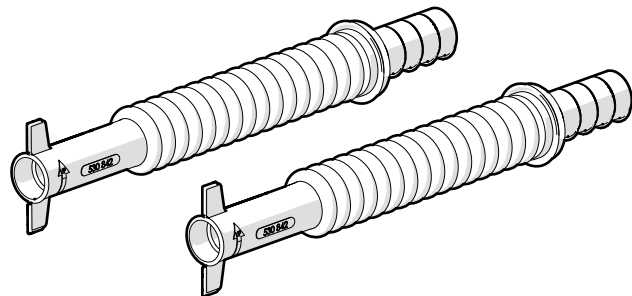

M08



x 6

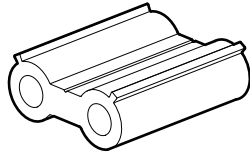

x 6

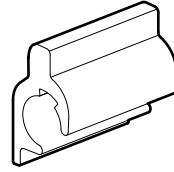

x 6

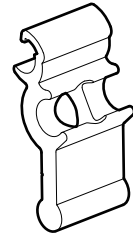

x 6

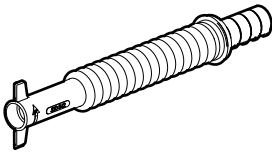

x 2

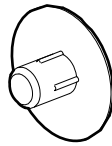

x 12 / x 24



x 6

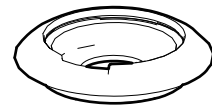

x 6

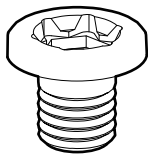

x 6

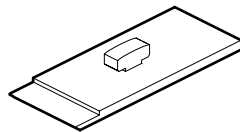

x 2

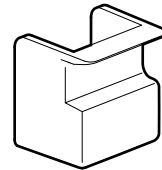

x 2

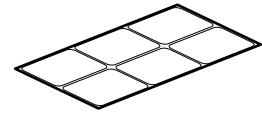

x 1

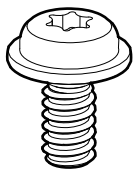

x 4

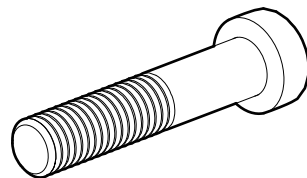

x 6

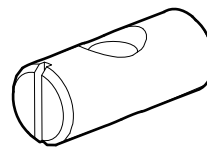

x 6



x 6

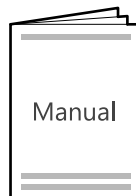

x 1

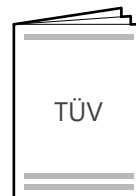

x 1



The contents of the kit may vary for different car models